

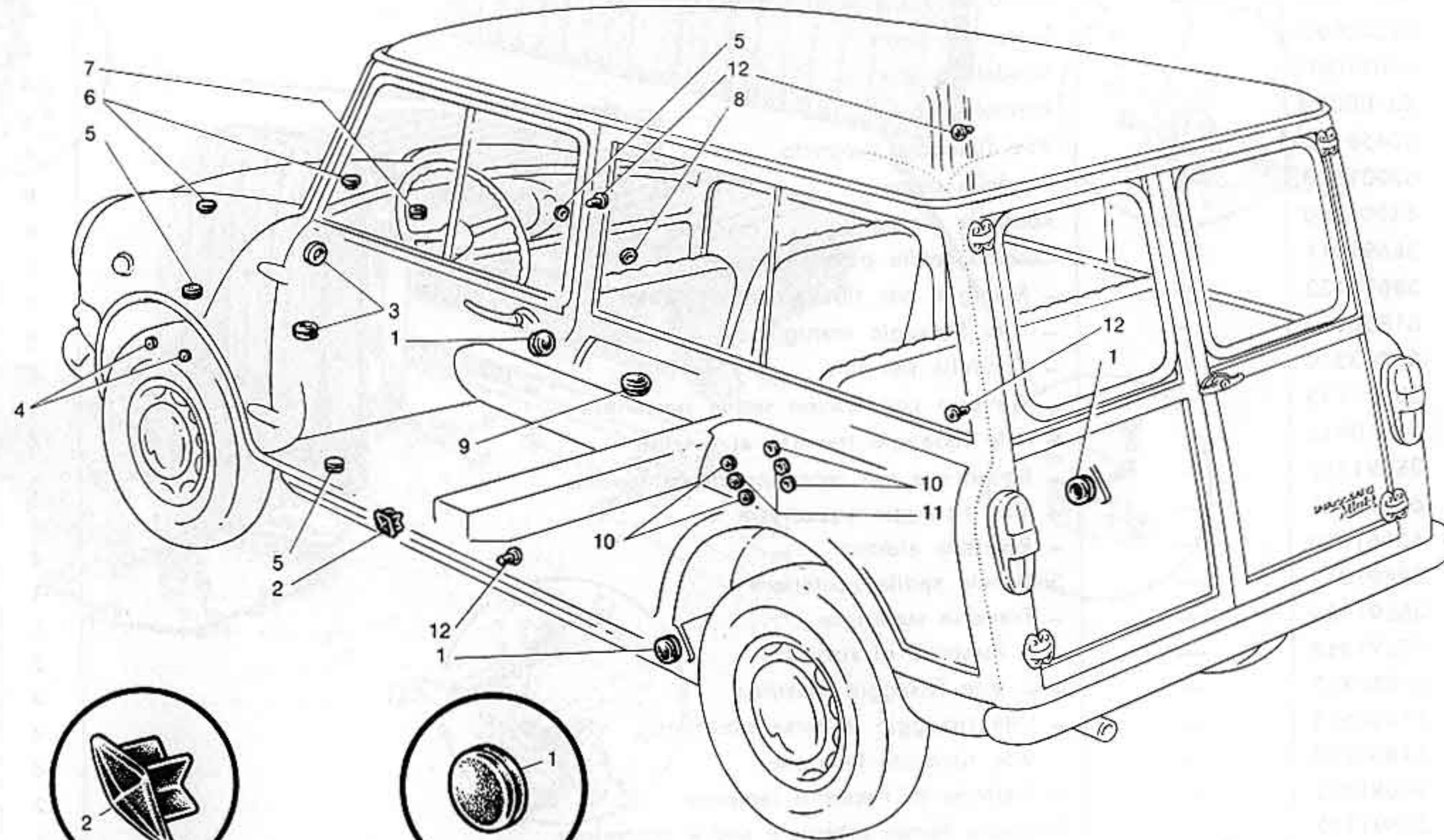

TAPPI E PASSACAVI

Tav. AX

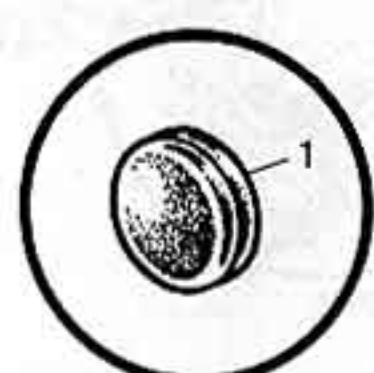
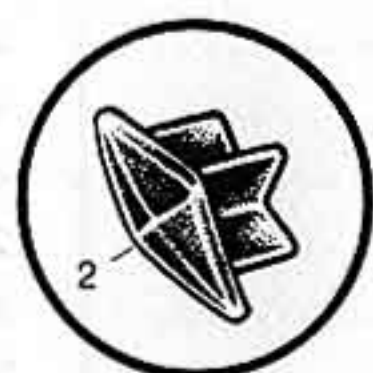
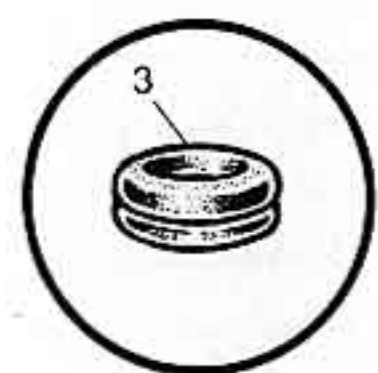
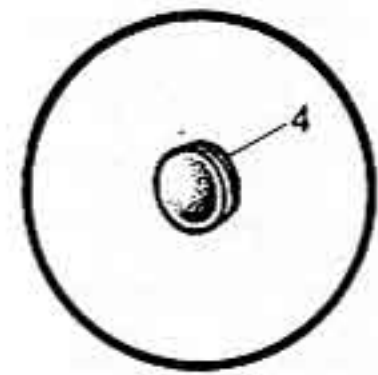
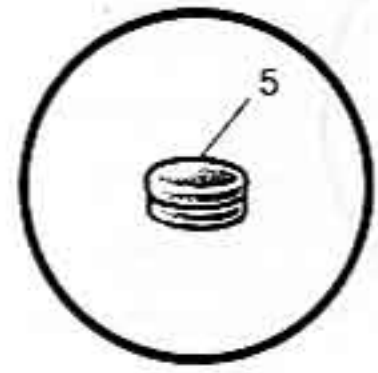
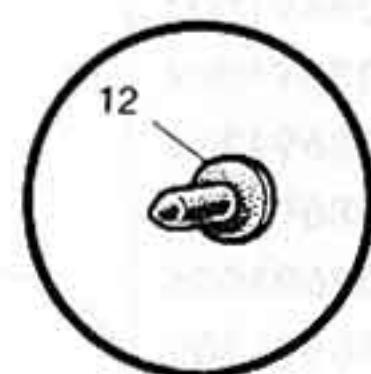
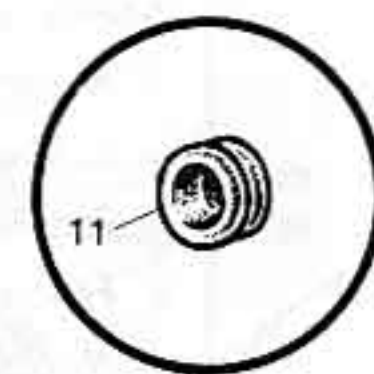
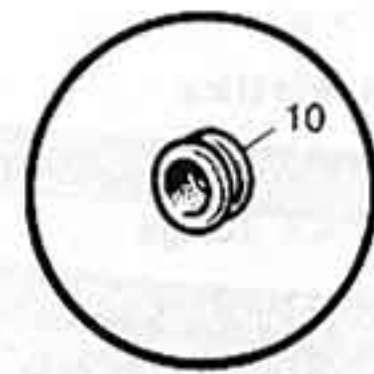
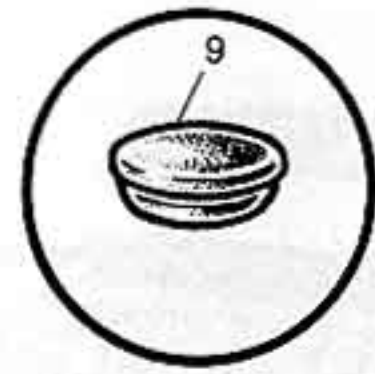
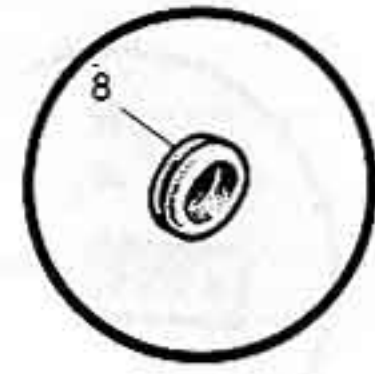
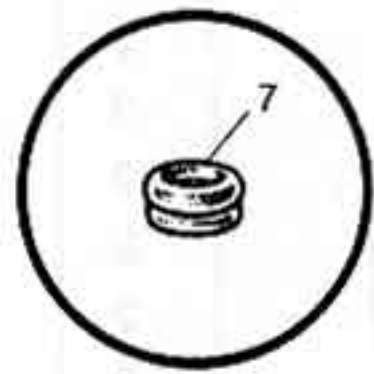
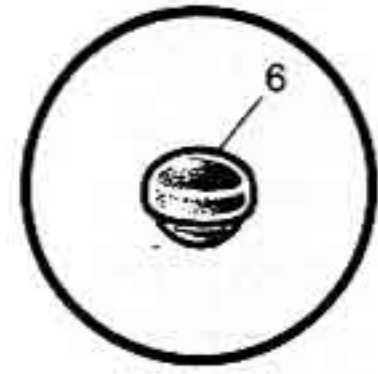

G-38-044



## TAPPI E PASSACAVI

Tav. AX

N. figura	Matricola Italiana	Matricola B.M.C.	Denominazione	Quantità	Aggiornamenti
AX1	65000220	—	Tappo chiusura foro piantone guida D. ....	1	.....
	65000220	—	Tappo per foro copertura braccio sospensione posteriore .....	2	.....
AX2	34211313	—	Tappo chiusura foro martinetto .....	2	.....
AX3	65010100	—	Passacavo per cablaggio .....	2	.....
AX4	38211306	—	Tamponcino per fianchetti vano motore .....	4	.....
AX5	65000130	—	Tappo per fianchetti vano motore .....	2	.....
	65000130	—	Tappo per foro fissaggio molletta tenuta flessibili tachimetro .....	1	.....
	65000130	—	Tappo per chiusura fori scarico vernice porte .....	4	.....
AX6	38211300	—	Tamponcino battuta cofano motore .....	2	.....
AX7	65010085	—	Passacavo per tubo carburatore .....	1	.....
AX8	65000160	—	Tappo per lamiera cruscotto .....	1	.....
AX9	31211305	—	Tappo chiusura fori scarico vernice pavimento e bagagliaio .....	7	.....
AX10	65000100	—	Tappo per fori fissaggio cintura di sicurezza .....	4	.....
AX11	65000110	—	Tappo per foro centrale cintura di sicurezza .....	2	.....
AX12	33211335	—	Tappi chiusura fori cintura sicurezza .....	4	.....